

**PMCQ14A
14-Inch Color
Quad Monitor**

**Installation/
Operation Manual**

C1970M-A (7/01)

CONTENTS

Section	Page
IMPORTANT SAFEGUARDS AND WARNINGS	3
DESCRIPTION	4
FEATURES	4
OVERVIEW	4
INSTALLATION	6
PROGRAMMING	7
CHECK OUT	8
OPERATION	8
DISPLAY	8
INTERCOM	10
ALARM	11
VCR RECORD/PLAYBACK	11
TECHNICAL SPECIFICATIONS	14
REGULATORY NOTICES	15
WARRANTY AND RETURN INFORMATION	16

LIST OF ILLUSTRATIONS

Figure	Page
1 Typical Application Using PMCQ14A Monitor	5
2 Examples of Camera Locations	5
3 Monitor Connections	6
4 Control Locations on Front of Monitor	7
5 Display Selections	9
6 Intercom Activities on Screen	10
7 Alarm Activities on Screen	11
8 Monitor Back Panel Controls and Connections	12
9 Monitor Controls	13

LIST OF TABLES

Table	Page
A Programming Menu	7
B Check-Out Procedure	8
C Display Functions	8
D Intercom Function	10
E Alarm Function	11
F Back Panel Reference Key	12
G Front Panel Reference Key	13

IMPORTANT SAFEGUARDS AND WARNINGS

Prior to installation and use of this product, the following WARNINGS should be observed.

1. Installation and servicing should only be done by qualified service personnel and conform to all local codes.
2. Unless the unit is specifically marked as a NEMA Type 3, 3R, 3S, 4, 4X, 6 or 6P enclosure, it is designed for indoor use only and it must not be installed where exposed to rain and moisture.
3. Only use replacement parts recommended by Pelco.
4. When used with the CCQ1400A-4 camera with audio, the PCMQ14A Color Quad Monitor is capable of being used as a two-way intercom system. Applications other than the intended use as a two-way intercom communications system **may violate Federal wiretapping laws**. No systems may be used to monitor audio without the expressed knowledge of the parties being monitored. A warning notice **must** be posted and plainly visible at all entrances to public and private premises utilizing the PCMQ14A/CCQ1400A-4 intercom system. Pelco assumes no liability for equipment being used for purposes other than the intended use as a two-way intercom system.
5. Do not attempt to disassemble the unit.
6. Do not remove screws or cover.
7. There are no user-serviceable parts inside.
8. Allow adequate air circulation to prevent internal heat build-up. Do not place the unit on or near materials that may hinder air circulation.
9. Do not install any of the system parts where they will be exposed to water, excessive dust or excessive vibration.

The product and/or manual may bear the following marks:



This symbol indicates that dangerous voltage constituting a risk of electric shock is present within this unit.



This symbol indicates that there are important operating and maintenance instructions in the literature accompanying this unit.



Please thoroughly familiarize yourself with the information in this manual prior to installation and operation.

DESCRIPTION

FEATURES

- Observe up to Four Camera Images at Once or in Sequence
- Programmable Dwell Time for Each Camera During Sequence Mode
- Picture-In-Picture (PIP) View in Horizontal or Vertical Format
- 2X Digital Zoom and Freeze Functions
- Alarm Inputs for Each Camera Channel on Back of Monitor
- Alarm Causes Channel to Come up with Full View
- Programmable TTL Compatible Alarm Output on Monitor
- Video Loss Detector Sets Alarm Beep
- 4 Camera Inputs Through Mini-DIN or BNC Connectors
- Looping Outputs When Mini-DIN Connectors Are Used
- Common Video Output Through MONITOR OUT BNC Connector
- Impedance Switches for Channel and Common Video Output Terminations

OVERVIEW

The PMCQ14A Color Quad Monitor is the ideal choice when you need an easy-to-install video surveillance system for viewing up to four areas at once. Cameras of your choice or alternate video sources (such as VCRs) can be used.

All monitor controls are located on the front of the unit. An observer can change the display to zoom in on a single camera with the touch of a button. Camera ID is displayed on the screen and is easily programmed.

In addition to its video capabilities, the monitor offers alarm and intercom features. The alarm lets you install a "call" button near the camera so that a person on camera can get the attention of the observer. The monitor has audio intercom capabilities that function only when CCQ1400A-4 cameras are used.

VCR connections are provided for recording cameras.

Alarm connections are provided on the back of the monitor. These connections serve as inputs to connect alarm contacts directly to the monitor when using a camera without alarm inputs. If not used as inputs, they can be used as outputs to provide a TTL compatible interface for operating alarm annunciators or other notification devices. Connections are easily made via push-in type wire connectors. An alarm trigger output is also provided on the push-in type wire connector. This can be used to automatically start a VCR when an alarm occurs.

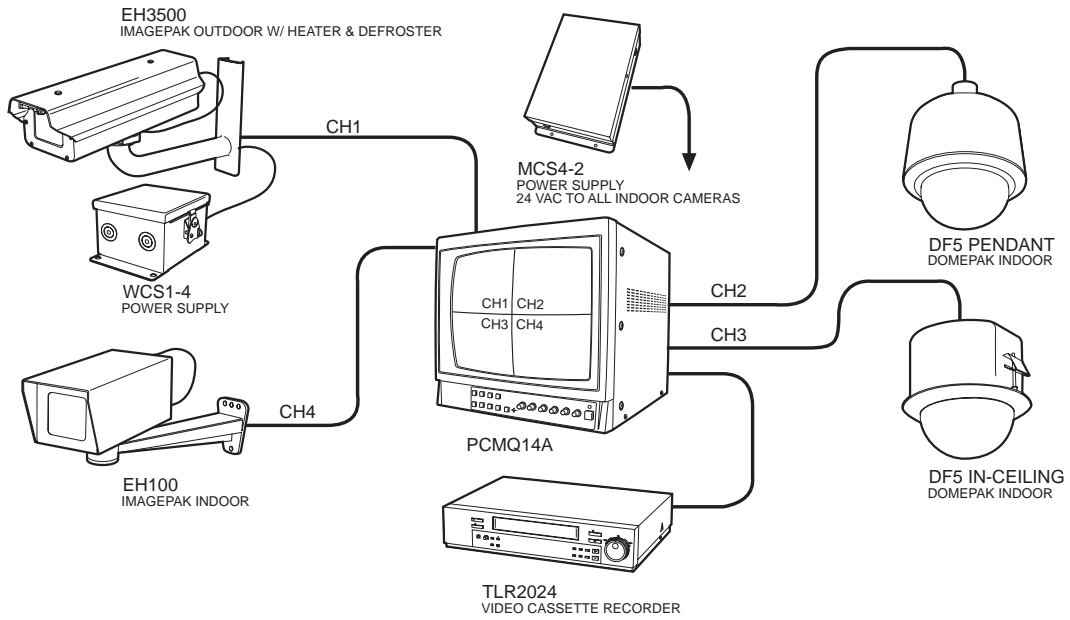

Figure 1. Typical Application Using PCM14A Monitor

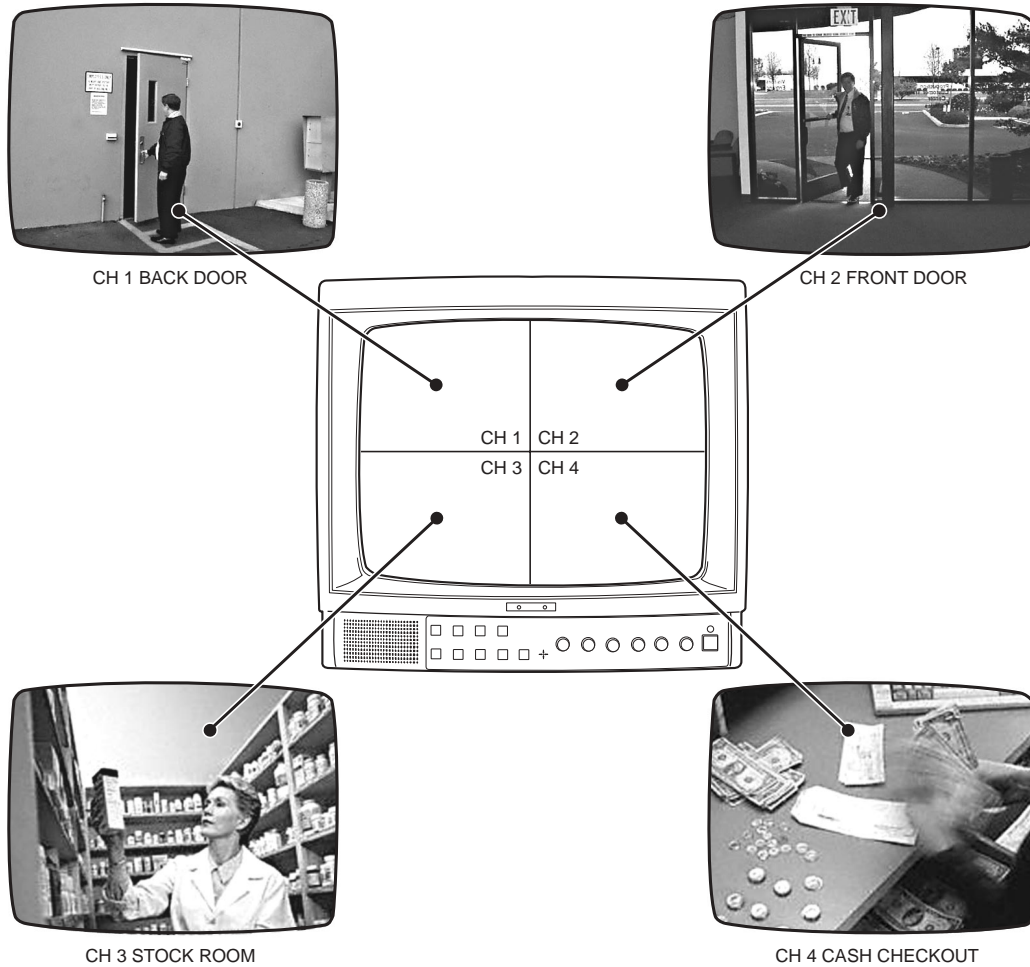
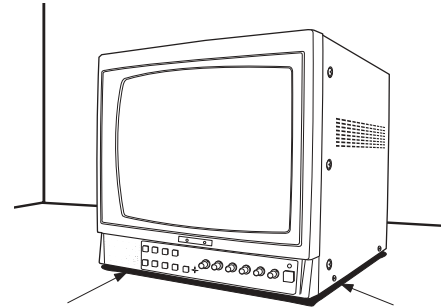

Figure 2. Examples of Camera Locations

INSTALLATION

NOTE: The mini-DIN (IN) connectors are for use with CCQ1400A-4 cameras.

1. Place monitor on a stable surface such as a shelf or desk top.
2. Connect cameras or alternate video sources to the desired channel IN/OUT connectors on the back of the monitor (refer to Figure 3).
3. Set impedance switches to the 75-ohm position (refer to Figure 3).
4. If alarm contacts are used, run wires from the contacts to the monitor and connect at the push-in connector on the back (refer to Figure 3).
5. If used, connect a VCR to the VIDEO/AUDIO IN/OUT jacks and/or MONITOR OUT connector, depending on the type of connectors on the VCR (refer to Figure 3). If MONITOR OUT is not used for a VCR, another monitor can be connected. If MONITOR OUT has equipment connected to it, set the impedance switch to HI. If MONITOR OUT is unused, set the switch to 75 ohms.
6. Plug in the power cord (refer to Figure 3).
7. Turn on MAIN switch on the back of the monitor (refer to Figure 3). Then press the POWER button on the front of the monitor.
8. The monitor begins operation using the factory set defaults. To re-program the monitor follow the procedure in Table A in the *Programming* section.
9. Test according to the check-out procedure in Table B.



BE SURE THERE IS AIR SPACE BELOW MONITOR. DO NOT BLOCK AIR SPACE BY PLACING MONITOR ON A SOFT SURFACE OR BY COUNTERSINKING SPOTS FOR THE FEET.

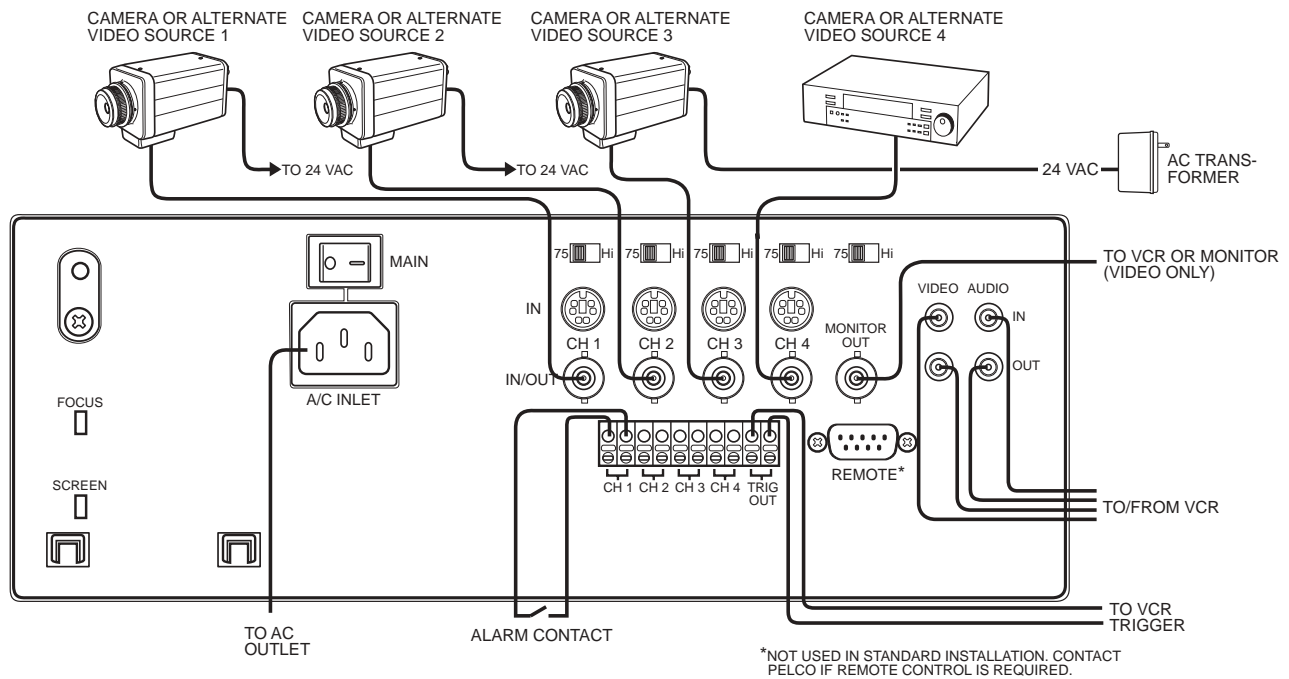

Figure 3. Monitor Connections

PROGRAMMING

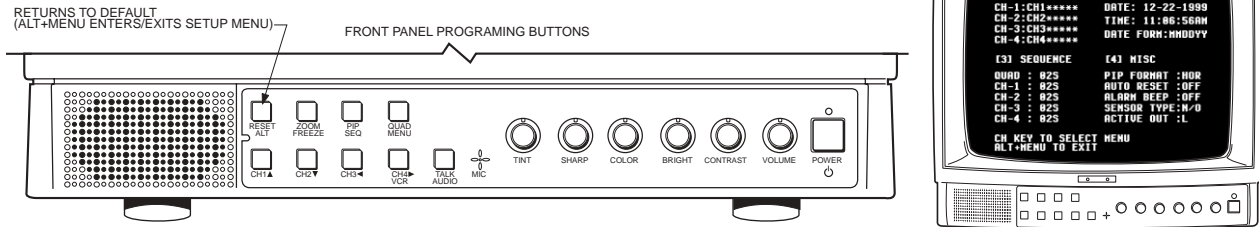

Figure 4. Control Locations on Front of Monitor

Table A . Programming Menu

Press ALT + MENU to toggle in or out of the programming menu.

Menu Item	Function	Procedure
[1] ID INPUT	Change channel name that appears on the screen.	<ol style="list-style-type: none"> Press CH1 (1 flashes yellow and the first character in the CH1 description turns yellow). Use the up and down arrows (CH1 and CH2 buttons) to change a character. Up advances it through the alphabet, then the numbers, and finally the ASCII symbols. Use the left and right arrows (CH3 and CH4 buttons) to advance to the next or return to the previous character position. When you have finished with CH1, press the right arrow until the first character of CH2 turns yellow. Continue to change characters and advance through the channels until all desired channel names are entered. Press RESET.
[2] DATE-TIME	Change date and time that appears on the screen.	<ol style="list-style-type: none"> Press CH2 (2 flashes yellow and YEAR in the date field turns yellow). Use the up and down arrows (CH1 and CH2 buttons) to change the YEAR. Use the right arrow (CH4) button to advance to the MONTH position. Use the up and down arrows (CH1 and CH2 buttons) to change the MONTH. Use the right arrow (CH4) button to advance to the DAY position. Use the up and down arrows (CH1 and CH2 buttons) to change the DAY. When you have finished with the date, press the right arrow until the first character of the TIME field turns yellow. Continue to change characters and advance through the time function until all desired changes are entered. Use the right arrow (CH4) button to advance to the DATE FORM position. Use the up and down arrows (CH1 and CH2 buttons) to change the date format display. <i>NOTE: The date field does not change in the Setup Menu after the date format is changed, but the selected date format is saved in memory. The new format will be displayed on the screen.</i> Press RESET.
[3] SEQUENCE	Change the amount of time that each screen is displayed during the sequence mode. (Screens always rotate in the order of QUAD, CH1, CH2, CH3, CH4.)	<ol style="list-style-type: none"> Press CH3 (3 flashes yellow and the time character in the QUAD field turns yellow). Use the up and down arrows (CH1 and CH2 buttons) to change the time. Time range is OFF, 1 to 30 seconds. Use the left and right arrows (CH3 and CH4 buttons) to advance to the next or return to the previous channel position. Continue to change channels and advance through the times functions until all desired changes are entered. Press RESET.
[4] MISC	Change the PIP Format (horizontal or vertical), Auto Reset time (off, 1 to 60 seconds, Alarm Beep (on or off alarm SensorType (normally open or normally closed and Active Out (TTL high to alarm or TTL low to alarm).	<ol style="list-style-type: none"> Press CH4 (4 flashes yellow) (The format character in the PIP FORMAT field turns yellow) Use the left and right arrows (CH3 and CH4 buttons) to advance to the next or return to the previous field. Continue to change fields and advance through the settings until all desired changes are entered. Press RESET.
EXIT	Return to normal display mode.	Press ALT + MENU

CHECK OUT

Table B. Check-Out Procedure

This procedure assumes that power is on.

Step	Procedure	Results
1	Calibrate cameras.	Follow the manufacturer's recommendations for calibration.
2	Press the QUAD/MENU button.	See quad display.
3	Press the CH 1 button.	See channel 1 image full screen.
4	Press the CH 2 button.	See channel 2 image full screen.
5	Press the CH 3 button.	See channel 3 image full screen.
6	Press the CH 4 button.	See channel 4 image full screen.
7	Press the PIP/SEQ button.	See PIP display.
8	While holding the RESET/ALT button, press the PIP/SEQ button.	See each channel image displayed full screen in sequence.
9	Press any channel button, then press the ZOOM/FREEZE button. Use arrow keys to move the highlighted area. Press the QUAD/MENU button. Press the RESET/ALT button.	Zoom area is highlighted in the center of the screen. The highlighted area moves to different parts of the screen. The image zooms to show the selected area full screen. See the selected channel image full screen (normal).
10	Put an object in the area being observed by the selected camera. While holding the RESET/ALT button, press the ZOOM/FREEZE button. Remove the object from the observed area. Press the RESET/ALT button.	See the object on the screen. Any movement will be seen. See the object frozen on the screen. No movement will be seen. The object remains on the screen. The object disappears and movement is once again seen.
11	Check-out is complete.	

OPERATION

| The buttons below the screen control the programming and control functions.

DISPLAY

| The monitor display can show all cameras in a quad display, show all cameras with one prominent (picture-in-picture), show only one camera, sequence between all cameras, zoom, and freeze (refer to Figure 5).

Table C. Display Functions

Function	To Activate Press	To Deactivate Press
Show all cameras (quad).	QUAD	PIP, CH1, CH2, CH3, or CH4
Show picture-in-picture (PIP).	PIP. Each time you press PIP, the prominent camera is stepped through CH1, CH2, CH3, CH4.	QUAD, CH1, CH2, CH3, or CH4
Show one camera.	CH1, CH2, CH3, or CH4.	PIP, QUAD, or another camera
Sequence all cameras.	ALT + SEQ.	QUAD, PIP, CH1, CH2, CH3, or CH4.
Zoom (works only in single-camera mode).	ZOOM. Use arrow keys (CH1, CH2, CH3, CH4) to locate zoom area where you want it. Then press QUAD to expand the view. The arrow keys will still function to move the image area.	ZOOM
Freeze (works in any mode but zoom).	ALT + FREEZE In QUAD and PIP modes next press the desired camera channel. You can press more than one channel.	ALT + FREEZE

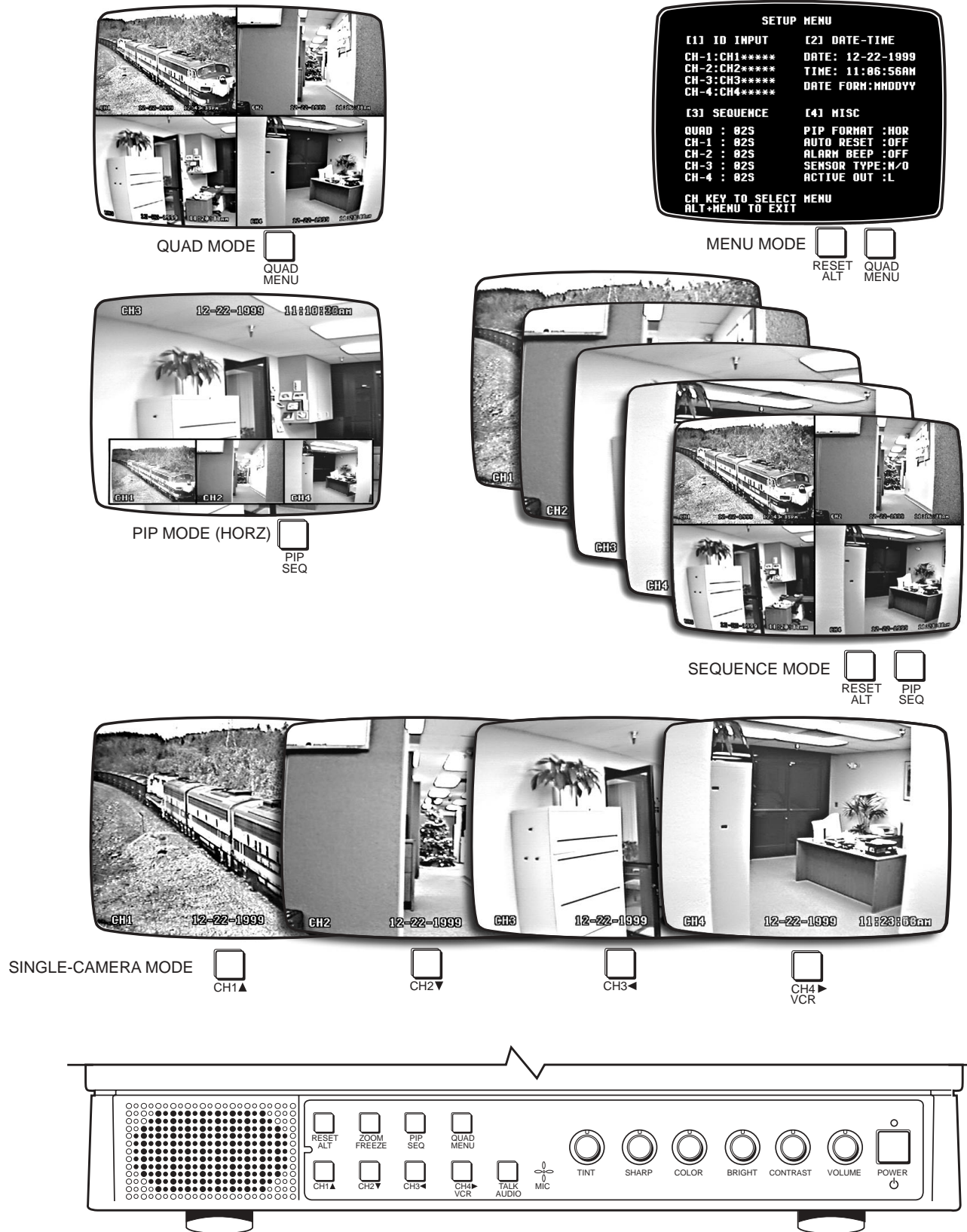

Figure 5. Display Selections

INTERCOM

NOTE: The intercom function is available only when CCQ1400A-4 cameras are used.

The intercom operates with one camera at a time. When the monitor is in quad display mode, a speaker icon appears next to the channel number to show which camera has the intercom active.

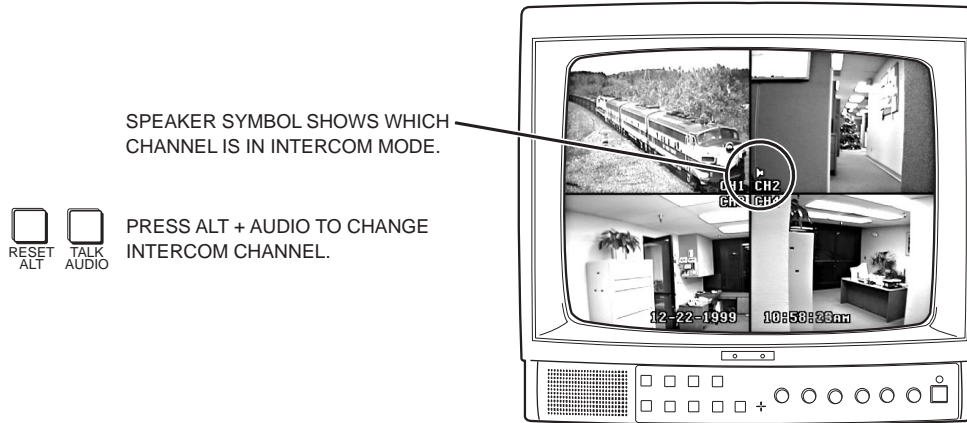

Figure 6. Intercom Activities on Screen

Table D. Intercom Function

Intercom Function	Action
Listen channel X	In quad mode, hold the ALT/RESET button and repeatedly press and release the AUDIO/TALK button until the speaker icon appears in the window of the desired channel.
Talk channel X	Perform listen step described above. Release the ALT/RESET button and press and hold the AUDIO/TALK button. Speak in a normal voice. Release button to hear response. Adjust volume control, if necessary.

NOTE: You can operate the intercom when the other display modes are active (single channel and PIP), but you cannot change the channel unless you are in Quad mode.

ALARM

The alarm operates with any or all cameras at once. ALM flashes at the top center of the screen and the display automatically switches to show the camera that has the alarm.

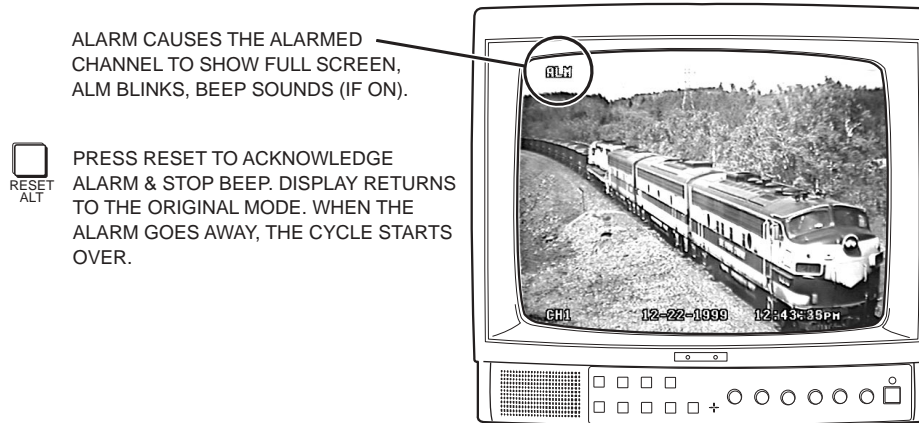

Figure 7. Alarm Activities on Screen

Table E. Alarm Function

Alarm Function	Action
Alarm occurs at a camera location.	The display switches to show a full-screen display of the camera that has the alarm and ALM flashes at the top center of the display. If alarm beep is programmed ON, the beep sounds for the programmed time period.
Manually acknowledge the alarm.	Press the RESET button. The display returns to the mode it was in before the alarm happened. The alarm beep stops. If the alarm condition still exists, ALM appears at the top of the screen.
Alarm is automatically reset (if the alarm has not been manually acknowledged).	If the programmed reset time has passed, the display returns to the mode it was in before the alarm happened. The alarm beep stops. If the alarm condition still exists, ALM appears at the top of the screen.
The condition that caused the alarm returns to normal.	Display switches as described above when an alarm occurs at a camera location.
Manually acknowledge the return to normal.	Press the RESET button. The display returns to the mode it was in before the alarm returned to normal. The alarm beep stops. ALM disappears from the top of the screen.
Return to normal is automatically reset (if the alarm has not been manually acknowledged).	If the programmed reset time has passed, the display returns to the mode it was in before the alarm returned to normal. The alarm beep stops. ALM disappears from the top of the screen.

VCR RECORD/PLAYBACK

If a VCR is connected at the Video and Audio jacks (refer to Figure 3), the image displayed on the screen can be recorded. To enter the playback mode, hold the ALT button while you press the VCR button; the screen displays VCR playback. Press Reset to return to the normal display mode.

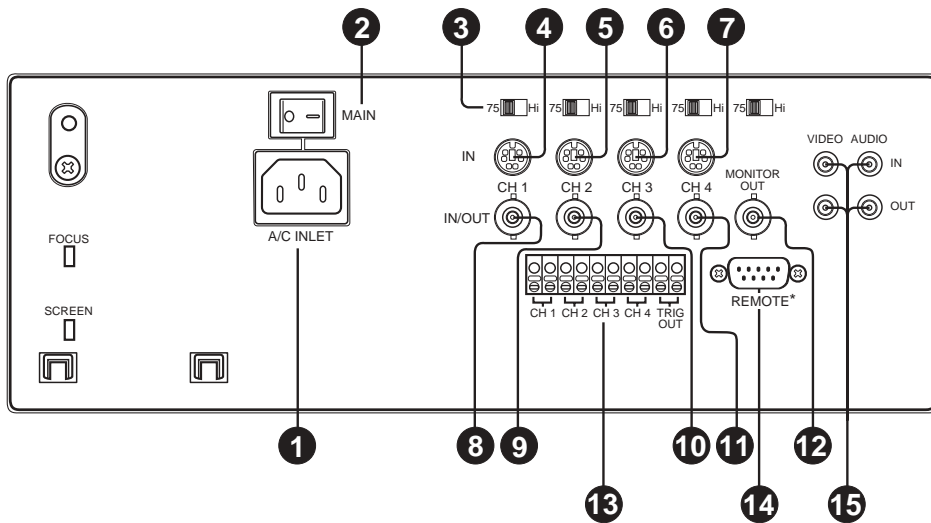

Figure 8. Monitor Back Panel Controls and Connections

Table F. Back Panel Reference Key

Reference Number	Description	Function
1	Power inlet	Accepts 110 to 240 Volts AC, 50/60 Hz power.
2	Main power switch	Controls power to monitor and cameras.
3	75-ohm/High impedance switch	Camera inputs: Set to 75 ohms unless looping outputs are used. Monitor output: Set to 75 ohms if output is unused. Set to HI if equipment is connected.
4-7	Video/Audio inputs (6-pin mini-DIN)	Input for CCQ1400A-4 cameras.
8-11	Video looping output/Video input (BNC)	Connect additional monitor or VCR to the channel, or connect a camera that uses BNC connector.
12	Monitor output	Connect VCR or additional monitor to the quad circuit.
13	Alarm input/output connector (10-position, snap-in type)	CH1, CH2, CH3, CH4: Connect alarm detection contacts (works the same as the alarm inputs on the camera) or alarm output to annunciators or other devices. Output switches from 5 VDC to ground on alarm with N.O. alarm contacts. Output switches from ground to 5 VDC on alarm with N.C. contacts. TRIG OUT: Connect a trigger input to start a VCR when an alarm is detected. Trig Out switches from ground to 5 VDC on alarm when Active Out (on the menu) is set for L. Trig Out switches from 5 VDC to ground on alarm when Active Out is set for H.
14	Remote control serial port (DB9)	This is normally not used. Contact Pelco for pin-out and coding.
15	VCR input/outputs (phono jacks)	Interface video and audio signals to and from a VCR.

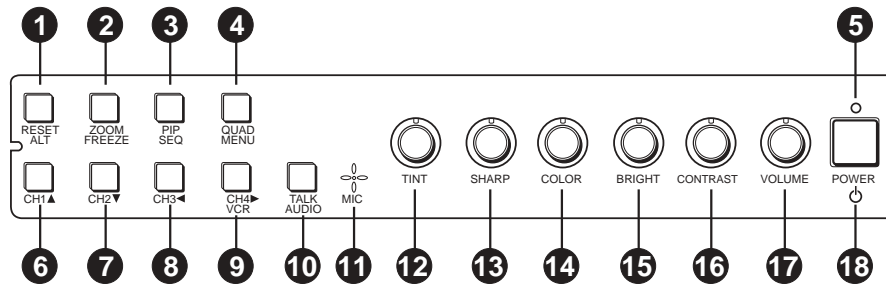

Figure 9. Monitor Controls

Table G. Front Panel Reference Key

Reference Number	Description	Function
1	Reset/ALT key	Resets alarm or video loss detection. When there is no alarm, use as ALT key to activate the alternate functions of the Zoom, PIP, Quad, CH4, and Talk keys.
2	Zoom/Freeze key	Toggles zoom mode when viewing single camera. In single-camera mode, freezes display when pressed while the ALT key is held in. In multiple-camera modes, freezes selected display when pressed while the ALT key is held in and then a channel key is pressed.
3	PIP/Sequence key	In display mode, shows picture-in picture view. Continuous pressing rotates the full-screen view. If pressed while the ALT key is held in, starts sequential viewing mode.
4	Quad/Menu key	In display mode, shows quad view. If pressed while the ALT key is held in, enters menu/setup mode.
5	Power Indicator LED	Illuminates when monitor power is on.
6	CH1/UP key	In display mode, shows full view of channel 1. In menu mode, moves cursor up or toggles setting.
7	CH2/Down key	In display mode, shows full view of channel 2. In menu mode, moves cursor down or toggles setting.
8	CH3/Left key	In display mode, shows full view of channel 3. In menu mode, moves cursor left or toggles setting.
9	CH4/Right key/VCR	In display mode, shows full view of channel 4. In menu mode, moves cursor right or toggles setting. If pressed while the ALT key is held in, display switches to the VCR playback mode.
10	Talk/Audio	Press to talk switch to activate microphone. Press and hold to talk. Release to listen. If pressed while the ALT key is held in, moves audio connection to the next channel.
11	Microphone	Speak in microphone to talk to people at camera locations.
12	Tint	Adjusts display color phase/flesh tones.
13	Sharpness	Adjusts display sharpness level.
14	Color	Adjusts display color saturation level.
15	Brightness	Adjusts display brightness.
16	Contrast	Adjusts display contrast.
17	Volume	Adjusts loudness of the speaker (effective only when cameras are equipped with the audio option or when playing back recorded sound from a VCR).
18	Power button	Controls power to monitor only. Power to the cameras and quad circuitry is controlled only with the switch on the back of the monitor.

TECHNICAL SPECIFICATIONS

ELECTRICAL

Input Voltage:	100 to 240 VAC, 50/60 Hz
Power Consumption:	70 watts
Signal Format:	NTSC
Scanning System:	2:1 interlace
Picture Elements:	512 (H) x 492 (V)
Horizontal Resolution:	350 TV lines (center)
Linearity:	Less than 12%
Audio Output:	1.1 W +/-0.2 W at 8-ohm resistive load
Pixel Format	
Single Screen:	720 (H) x 480 (V)
Quad Screen:	360 (H) x 240 (V)
PIP Screen:	208 (H) x 136 (V)
Refresh Rate:	30 frames per second (NTSC)
Digital Zoom:	2X
OSD Character:	16 x 20 bit map font (upper case alpha characters, numbers, and symbols)
Video Switching	
Time When Multiple Alarms Occur:	1 second
Maximum Character Display Format:	45 (H) x 24 (V) (1,080 characters)

GENERAL

Picture Tube:	14-inch diagonal color
Controls:	Sharpness, color, brightness, contrast, tint, and volume
Character Display:	8 alphanumeric characters each for camera, date, time, alarm, video loss, and freeze for each channel
Display Modes:	One camera, four cameras (quad), picture-in-picture (PIP), and VCR
Sequential Switching Mode:	Set dwell time from 1 to 30 seconds; OFF setting skips channel
Video Loss Detection:	All channels
Time Mode:	12-hour mode with AM/PM indicator
Alarm Inputs:	4, activated by N.O. or N.C. contact closure (programmable)
Alarm Output:	1, common to all 4 inputs, TTL compatible (programmable for high or low output)
Alarm Beep:	On or off (programmable)
Automatic Alarm Reset:	Set reset time from 1 to 60 seconds; OFF setting defeats auto reset (programmable)
Video/Audio Input Connectors:	4X6P mini-DIN
Video Input Connectors:	4 BNC
Video Looping Connectors:	4 BNC
Monitor Output Connector:	1 BNC
VCR Input/Output Connectors:	4 RCA (2 video and 2 audio)
Remote Port Connector:	DB9 male
Alarm Connector:	10-position, snap-in type (push-in wire)
Impedance Termination:	75 ohms or bridging for 4 video inputs (from cameras) and 1 monitor output
Dimensions:	13.68 (W) x 12.75 (H) x 14.68 (D) inches (34.75 x 32.38 x 37.29 cm)
Weight:	28.6 lb (13 kg)

ENVIRONMENTAL

Operating	
Temperature:	32° to 104°F (0° to 40°C)
Storage	
Temperature:	4° to 158°F (-20° to 70°C)
Humidity:	35% to 80%, non-condensing

(Design and product specifications subject to change without notice.)

REGULATORY NOTICES

Note: This equipment has been tested and found to comply with the limits of a Class A digital device, pursuant to part 15 of the FCC rules. These limits are designed to provide reasonable protection against harmful interference when the equipment is operated in a commercial environment. This equipment generates, uses, and can radiate radio frequency energy and, if not installed and used in accordance with the instruction manual, may cause harmful interference to radio communications. Operation of this equipment in a residential area is likely to cause harmful interference in which case the user will be required to correct the interference at his own expense.

PRODUCT WARRANTY AND RETURN INFORMATION

WARRANTY

Pelco will repair or replace, without charge, any merchandise proved defective in material or workmanship **for a period of one year** after the date of shipment.

Exceptions to this warranty are as noted below:

- Five years on FT/FR8000 Series fiber optic products.
- Three years on Genex® Series products (multiplexers, server, and keyboard).
- Three years on Camclosure® and fixed camera models, except the CC3701H-2, CC3701H-ZX, CC3751H-2, CC3651H-ZX, MC3651H-2, and MC3651H-ZX camera models, which have a five-year warranty.
- Two years on standard motorized or fixed focal length lenses.
- Two years on Legacy®, CM6700/CM6800/CM9700 Series matrix, and DF5/DF8 Series fixed dome products.
- Two years on Spectra®, Esprit®, ExSite™, and PS20 scanners, including when used in continuous motion applications.
- Two years on Esprit® and WW5700 Series window wiper (excluding wiper blades).
- Eighteen months on DX Series digital video recorders, NVR300 Series network video recorders, and Endura™ Series distributed network-based video products.
- One year (except video heads) on video cassette recorders (VCRs). Video heads will be covered for a period of six months.
- Six months on all pan and tilts, scanners or preset lenses used in continuous motion applications (that is, preset scan, tour and auto scan modes).

Pelco will warrant all replacement parts and repairs for 90 days from the date of Pelco shipment. All goods requiring warranty repair shall be sent freight prepaid to Pelco, Clovis, California. Repairs made necessary by reason of misuse, alteration, normal wear, or accident are not covered under this warranty.

Pelco assumes no risk and shall be subject to no liability for damages or loss resulting from the specific use or application made of the Products. Pelco's liability for any claim, whether based on breach of contract, negligence, infringement of any rights of any party or product liability, relating to the Products shall not exceed the price paid by the Dealer to Pelco for such Products. In no event will Pelco be liable for any special, incidental or consequential damages (including loss of use, loss of profit and claims of third parties) however caused, whether by the negligence of Pelco or otherwise.

The above warranty provides the Dealer with specific legal rights. The Dealer may also have additional rights, which are subject to variation from state to state.

If a warranty repair is required, the Dealer must contact Pelco at (800) 289-9100 or (559) 292-1981 to obtain a Repair Authorization number (RA), and provide the following information:

1. Model and serial number
2. Date of shipment, P.O. number, Sales Order number, or Pelco invoice number
3. Details of the defect or problem

If there is a dispute regarding the warranty of a product which does not fall under the warranty conditions stated above, please include a written explanation with the product when returned.

Method of return shipment shall be the same or equal to the method by which the item was received by Pelco.

RETURNS

In order to expedite parts returned to the factory for repair or credit, please call the factory at (800) 289-9100 or (559) 292-1981 to obtain an authorization number (CA number if returned for credit, and RA number if returned for repair).

All merchandise returned for credit may be subject to a 20% restocking and refurbishing charge.

Goods returned for repair or credit should be clearly identified with the assigned CA or RA number and freight should be prepaid. Ship to the appropriate address below.

If you are located within the continental U.S., Alaska, Hawaii or Puerto Rico, send goods to:

Service Department
Pelco
3500 Pelco Way
Clovis, CA 93612-5699

If you are located outside the continental U.S., Alaska, Hawaii or Puerto Rico and are instructed to return goods to the USA, you may do one of the following:

If the goods are to be sent by a COURIER SERVICE, send the goods to:

Pelco
3500 Pelco Way
Clovis, CA 93612-5699 USA

If the goods are to be sent by a FREIGHT FORWARDER, send the goods to:

Pelco c/o Expeditors
473 Eccles Avenue
South San Francisco, CA 94080 USA
Phone: 650-737-1700
Fax: 650-737-0933

REVISION HISTORY

Manual #	Date	Comments
C1970M	7/00	Original version.
C1970M-A	7/01	Date and time programming revised.

Pelco, the Pelco logo, Camclosure, Esprit, Genex, Legacy, and Spectra are registered trademarks of Pelco. Endura and ExSite are trademarks of Pelco.

©Copyright 2001, Pelco.
All rights reserved.